

Handwritten text in a cursive script, likely a historical record or journal entry, partially obscured by a compass rose.



deco JUNIOR



ARMADA
decowall[®]
WALLCOVERINGS



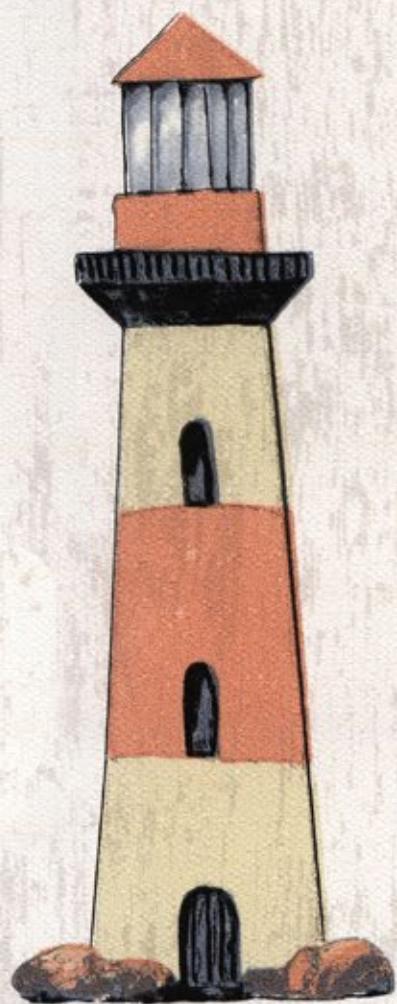

SEA

BEACH



1203-01

AN

BEACH

SUN

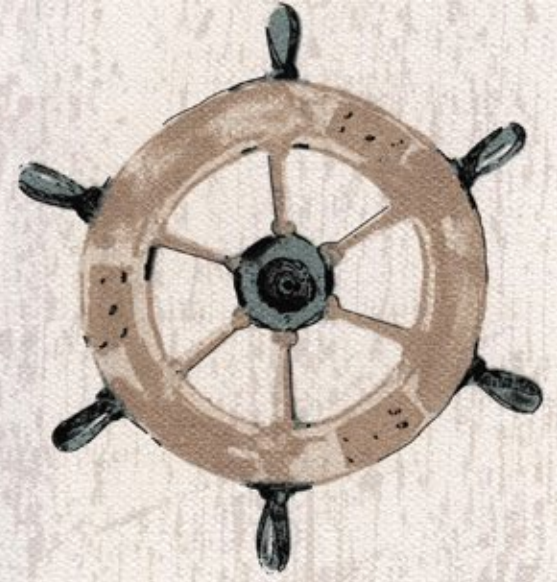

OCEAN

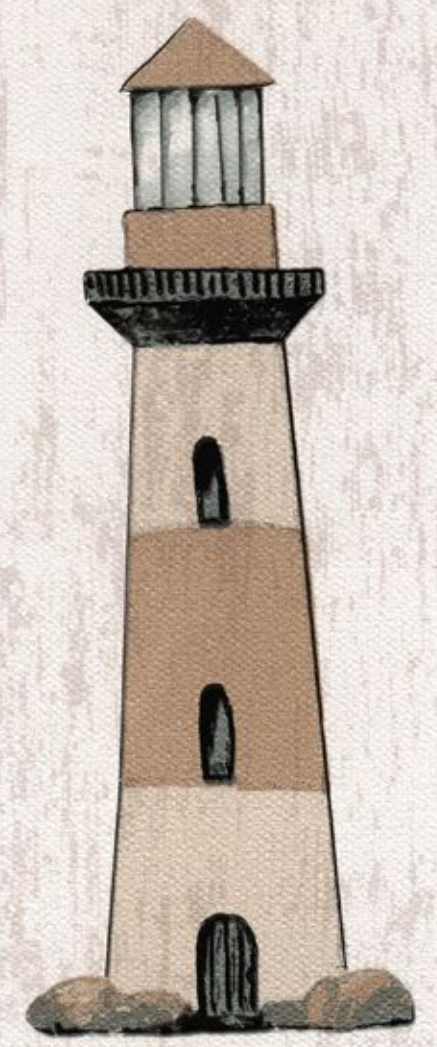

1203-02



1204-01

1204-03

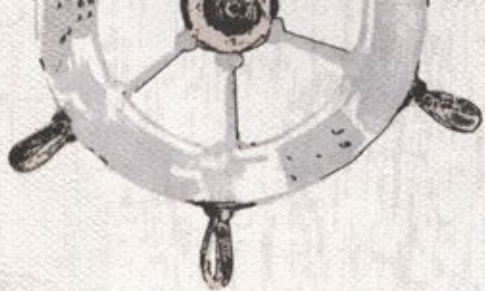

OCEAN



SUN

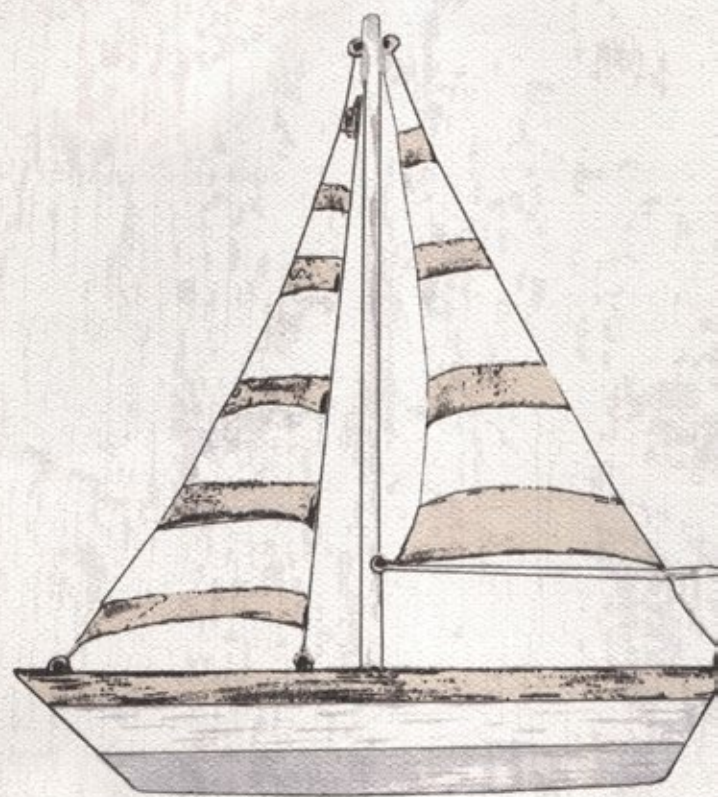
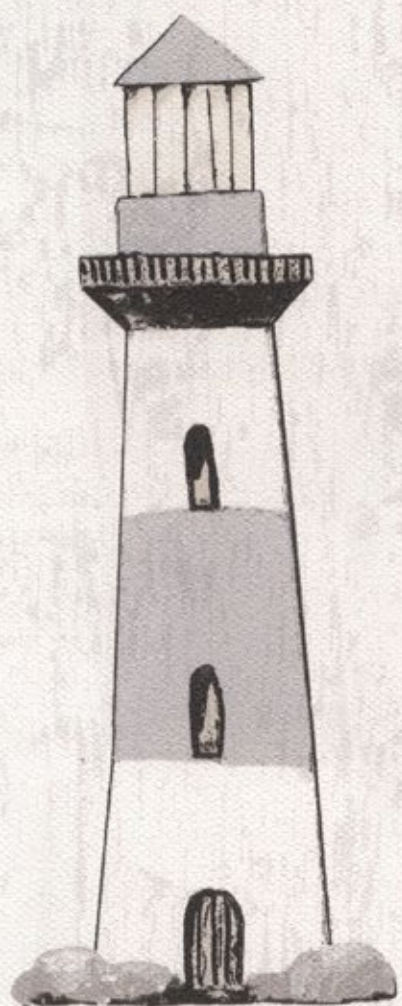
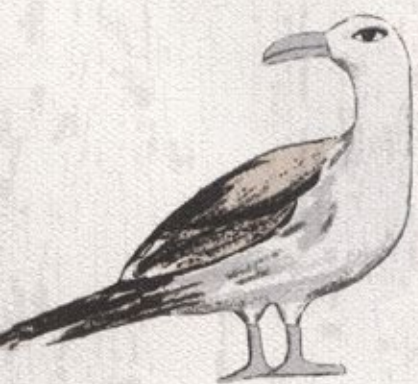

1203-03

SEA



*En dyr julestjerne
111 - 111 - 111
Kjærlighed og
Lykke*

sailor spirit

1207-01

Nautical





FROZEN SEA

*En Ar...
...
...
...*

FROZEN SEA

Russia

*Sailor
spirit*

Kazakhstan

Mongolia

China

Syria

Iraq

Iran

Afghanistan

Pakistan

Saudi Arabia

India

Thailand

Malaysia

Indonesia

Sri Lanka

Alaska, USA

Upernivik (Barrow)

Sigqaq (Point Hope)

Dead Horse / Prudhoe Bay

Greenland

Svalbard

Iceland

Faroe Islands

Norway

Sweden

Finland

Estonia

Latvia

Lithuania

*Nautical
traveler*

1206-01

1206-01

*Report of the Department of Agriculture
...
...*

*Report of the Department of Agriculture
...
...*



1205-01



Nautical Traveler

*Kata Dofales
do Defentes*

*Sailor
spirit*

1206-03

spirit



*Nautical
Traveler*

*by Walter
de la Roche*

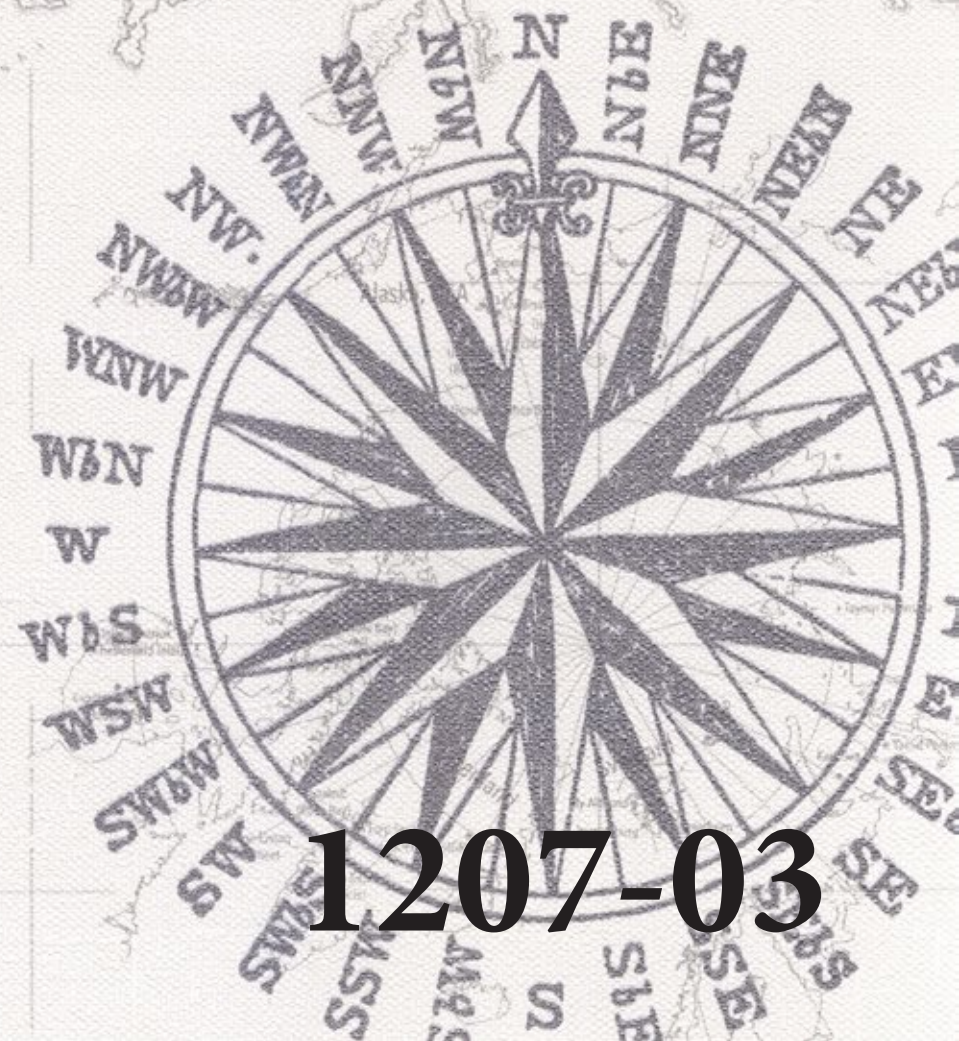
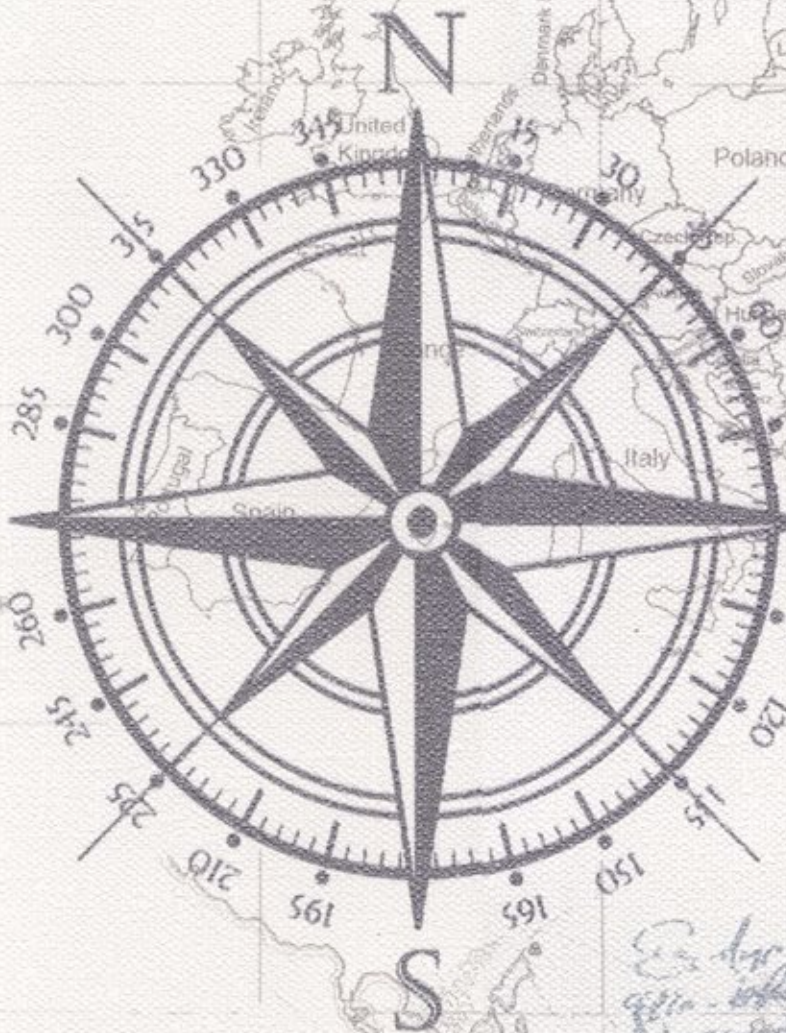

1207-03



United Kingdom
Germany
France
Spain
Italy
Greece
Türkiye
Poland
Ukraine
Belarus
Czech Rep.
Austria
Hungary
Romania
Bulgaria
Croatia
Serbia
Slovenia
Lithuania
Latvia
Estonia

Alaska, USA
Greenland
Svalbard

*En det påstådda området
av den stora havet
har en stor betydelse
för den världshandeln
som pågår där.*

*De stora havets betydelse
har alltid varit en central
del i världshandeln
och den kommer att
bli det i framtiden.*

*Sailor
spirit*

Russia
Kazakhstan
Mongolia
China
India
Iran
Iraq
Saudi Arabia
Yemen
Pakistan
Malaysia
Indonesia

1206-02

N + O



Sailor spirit



Nautical Traveler

*Map of the North Atlantic region
High latitude map from Concord, VA
15-16
Map of the North Atlantic region
High latitude map from Concord, VA*



1207-02



Sailor
spirit



Verpöngt Dattan befrachtet Passagiere
durch Masten und drei Concerth
17-41
Verpöngt Dattan befrachtet
durch Masten und drei
17

Nautical
Traveler

Verpöngt Dattan
durch Masten



1201-01

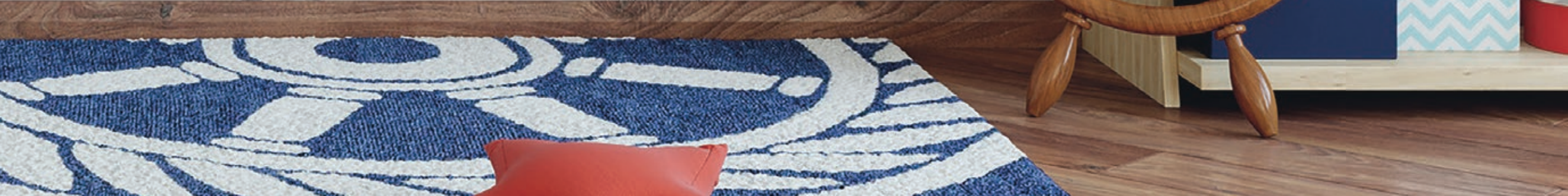

Nautical Traveler

1870

Two of the most important ingredients
of a sailor's life are his courage &
his skill.
The first is the result of
long practice and the
second is the result of
long practice and the
first.

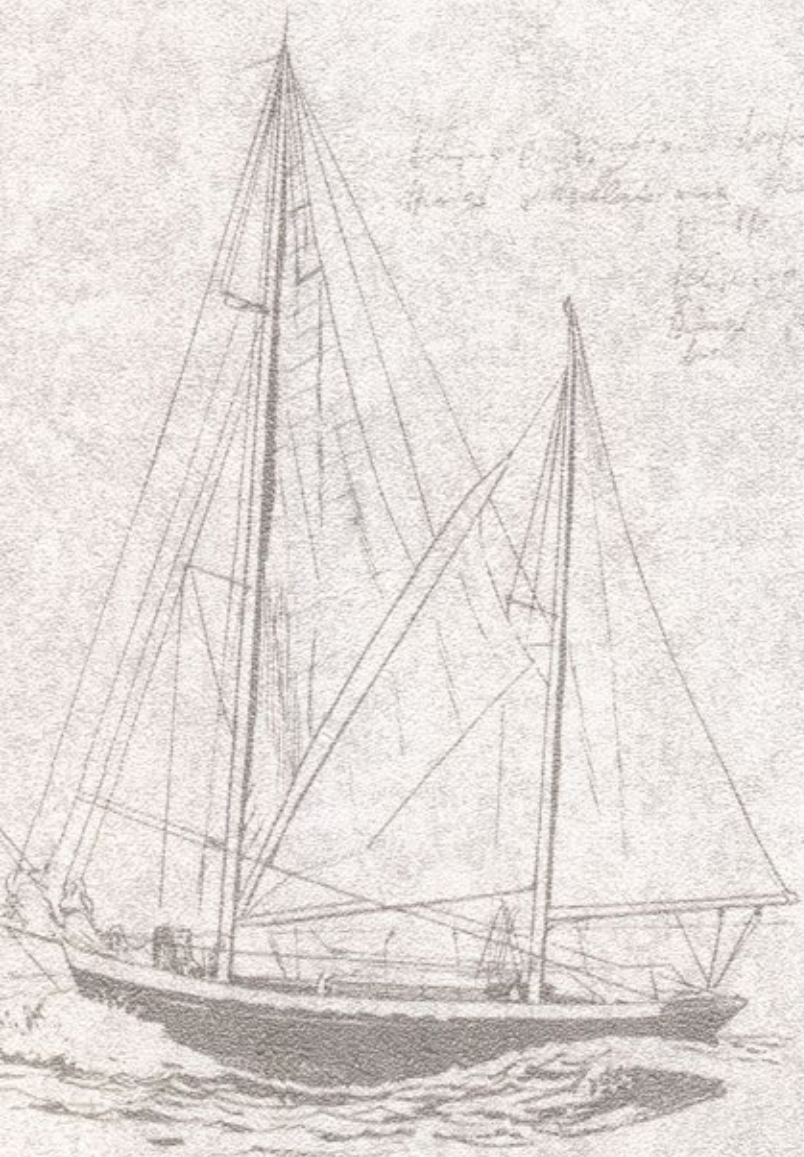

The first of the most important
ingredients of a sailor's life is
his courage & his skill.
The first is the result of
long practice and the
second is the result of
long practice and the
first.

1870



Sailor
spirit

1201-03

1202-01

1202-02

Traveler



*Two-masted schooner
with two masts
and two sails
on each mast*



*Nautical
Traveler*

*Two-masted schooner
with two masts*

*Single-masted schooner
with one mast
and one sail*



*Sailor
spirit*

1201-02

1202-03

POST OFFICE
★ CITY ★
ABC 1234

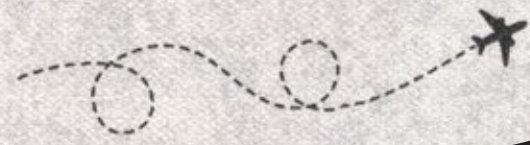
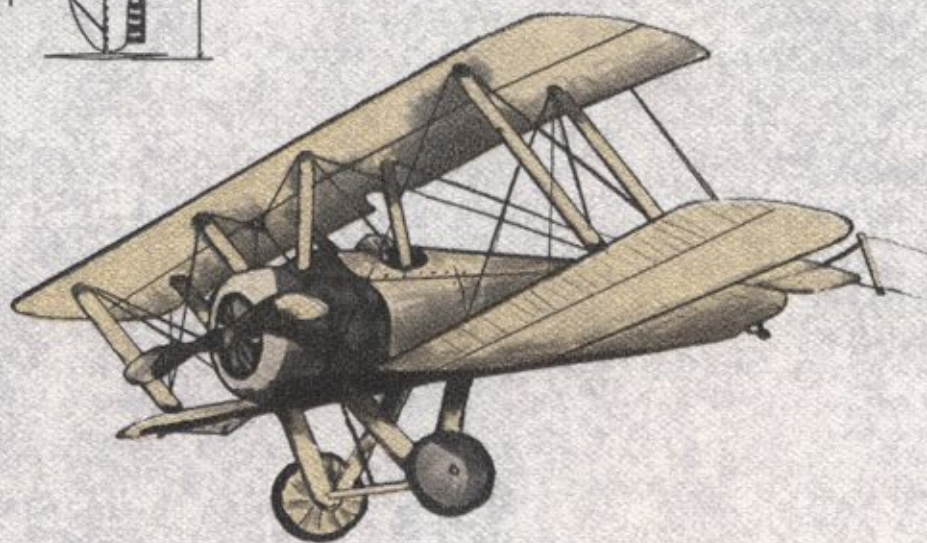
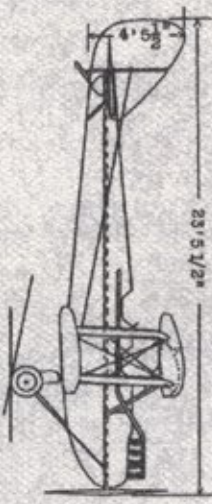
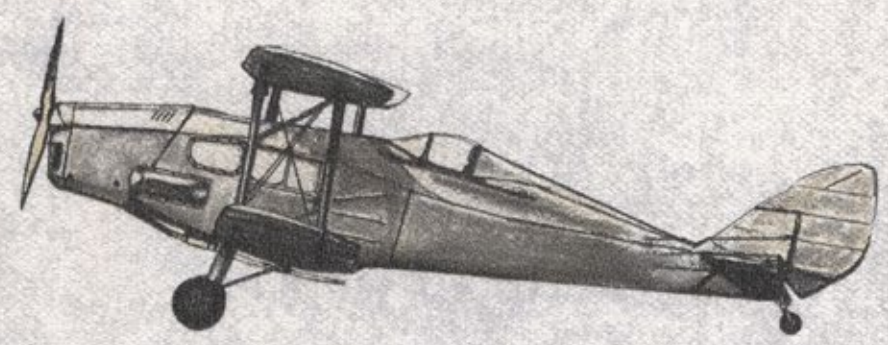
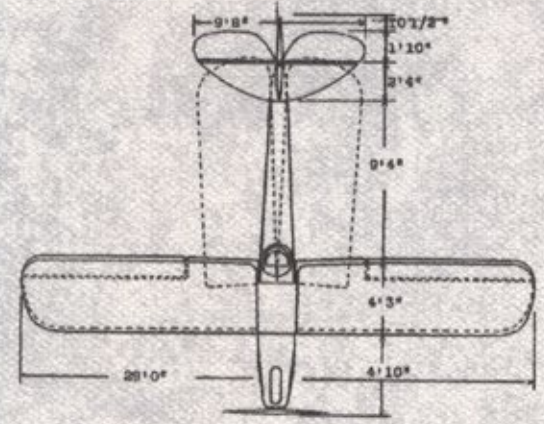
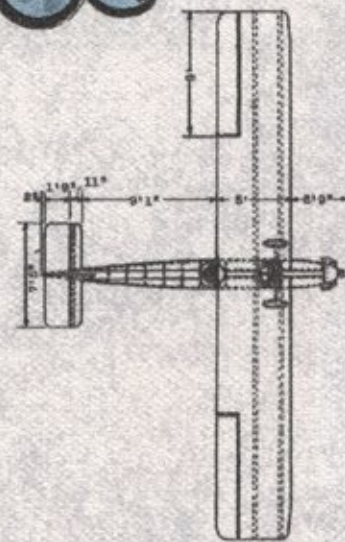
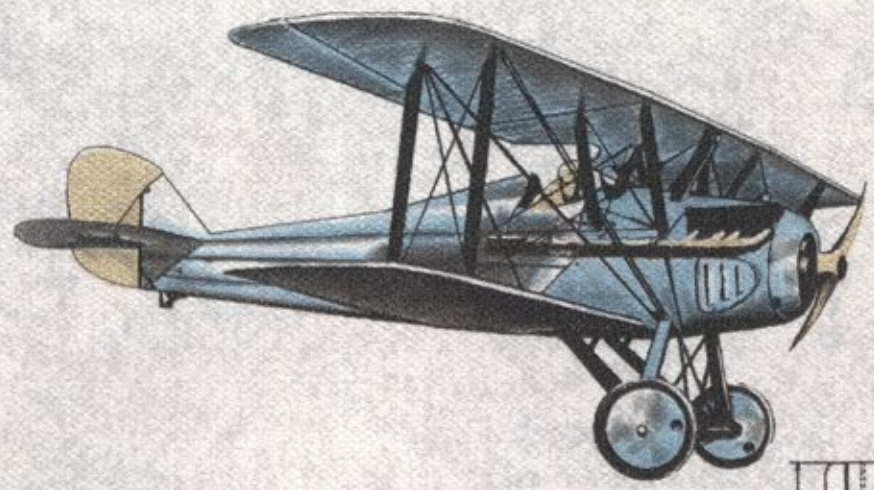
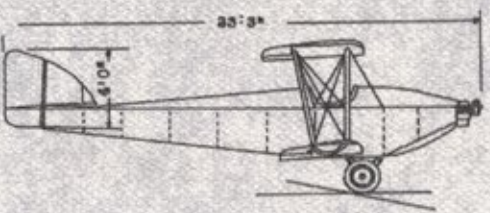
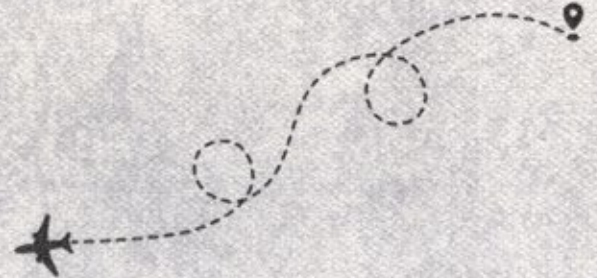

1209-01

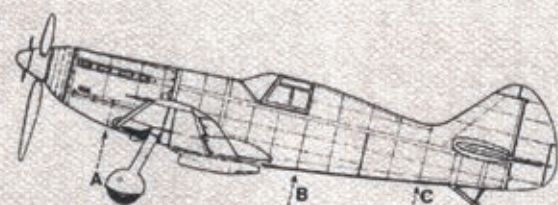
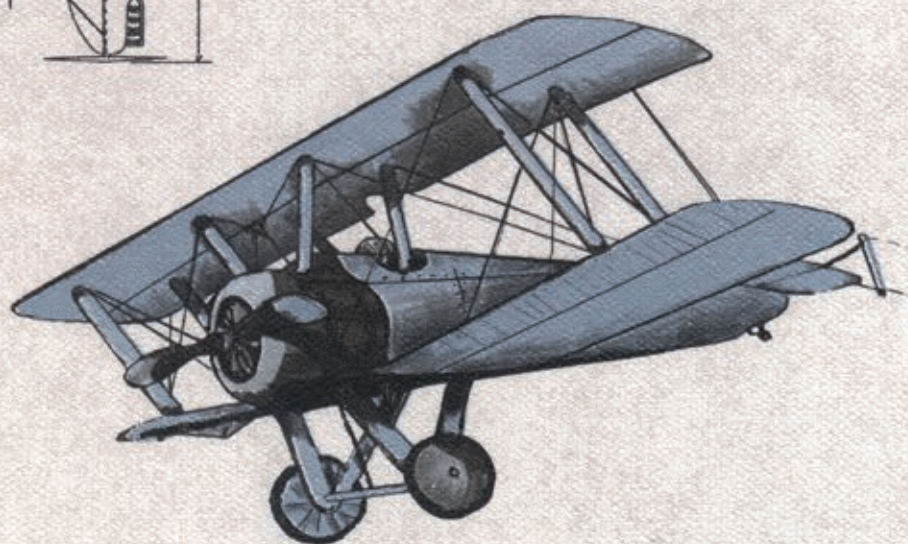
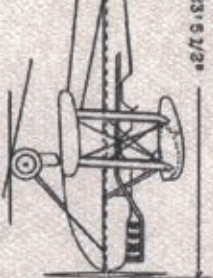

POST OFFICE
★ CITY ★
ABC 1234

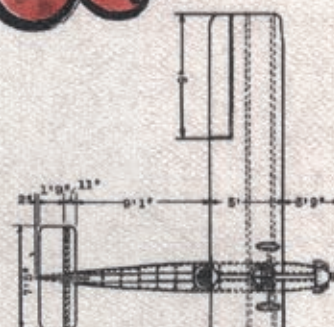
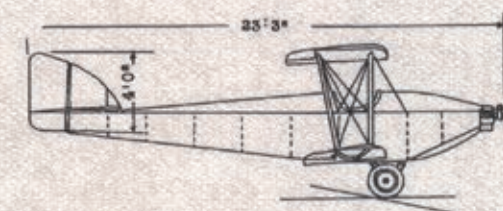

1209-03



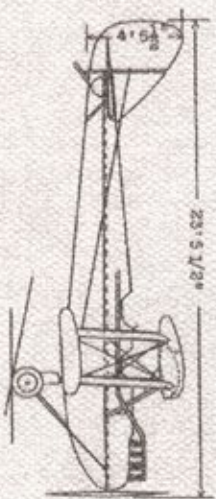
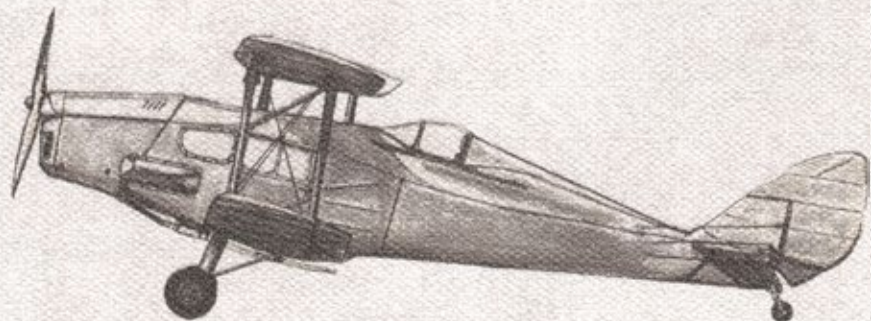
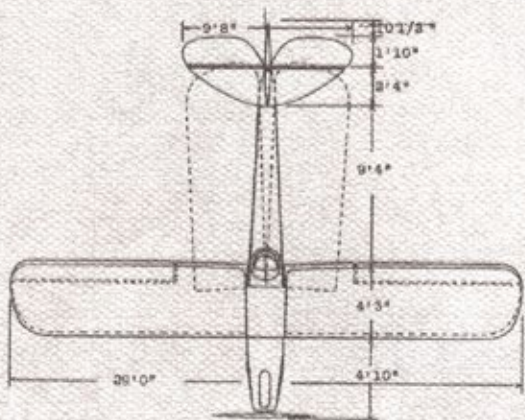
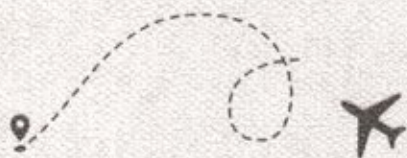
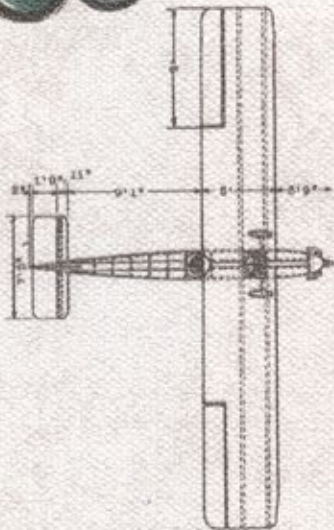
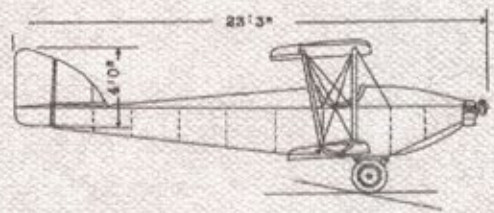

1209-02

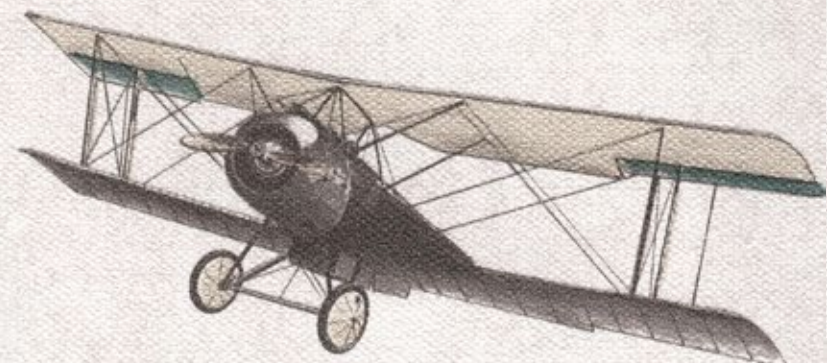
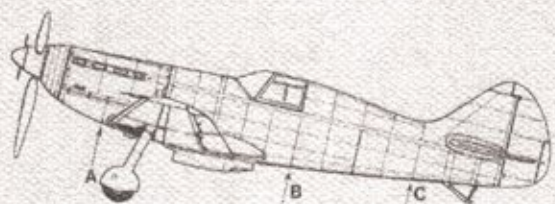

1210-03

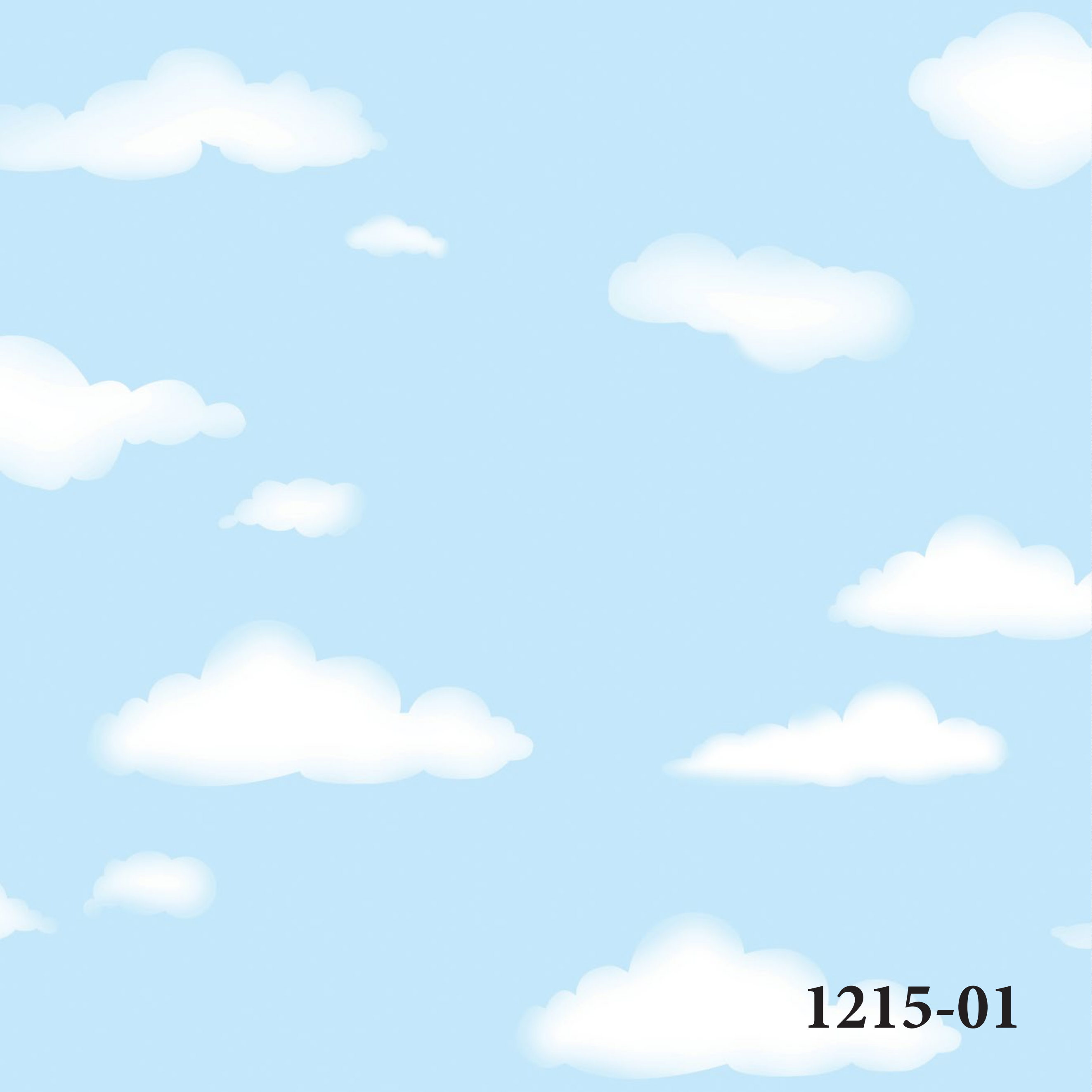

1215-01

1210-01

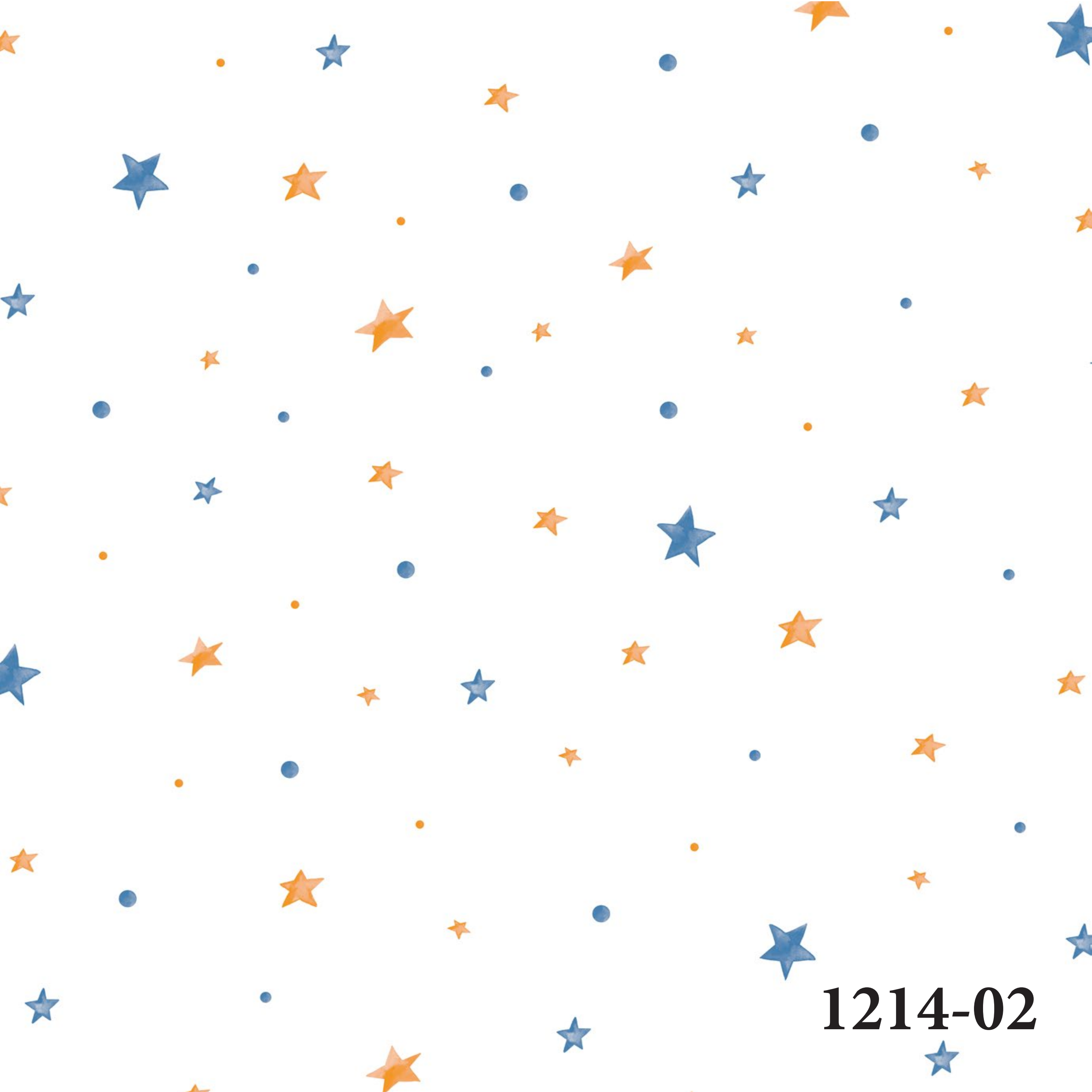

1214-02



1214-01

1219-04

1219-02



1208-01



1212-01

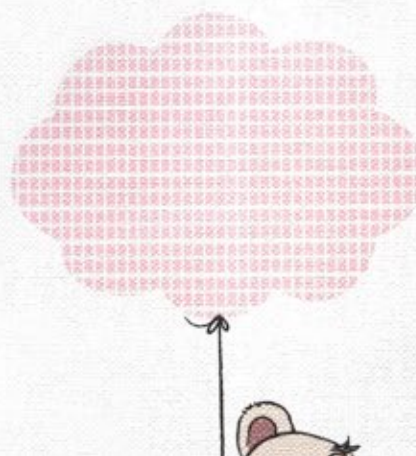
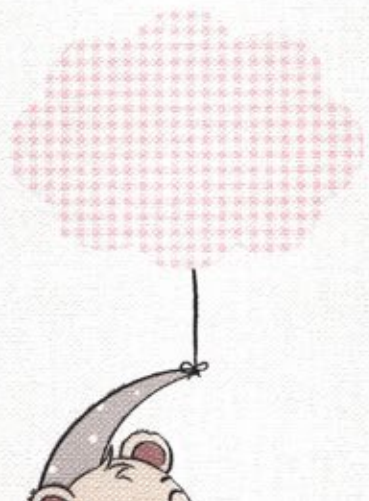

1208-02



1212-02

1216-01

1216-02



1217-01

1219-03



1217-02

1219-01

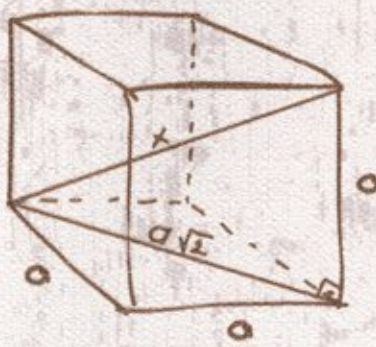

$$x^2 = a^2 + (a\sqrt{2})^2$$

$$x^2 = a^2 + 2a^2$$

$$x^2 = 3a^2$$

$$x = a\sqrt{3}$$

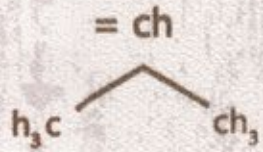
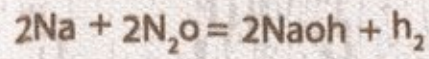
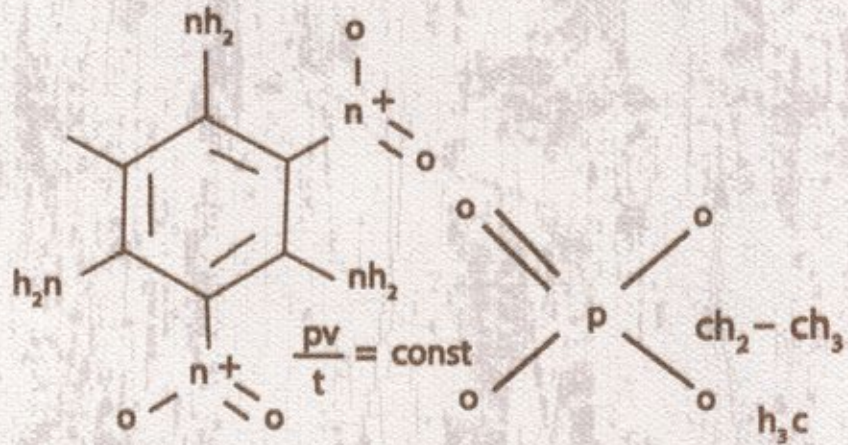
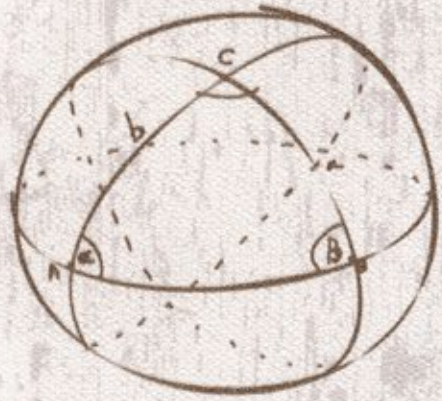
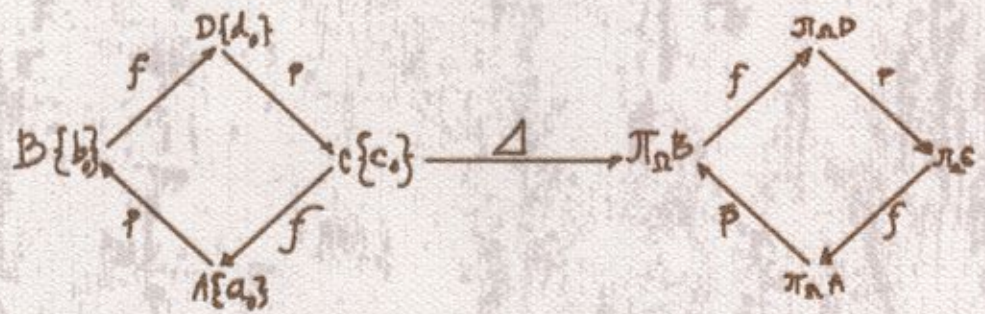

$$\frac{n \cdot (n+1)}{2}$$

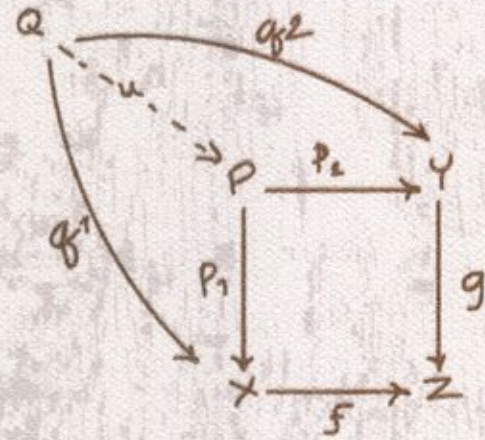

$$(x+y)^2 = x^2 + 2xy + y^2$$

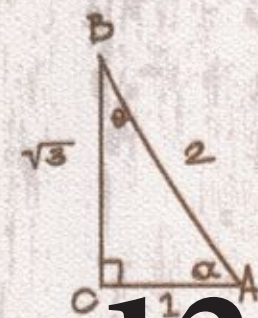
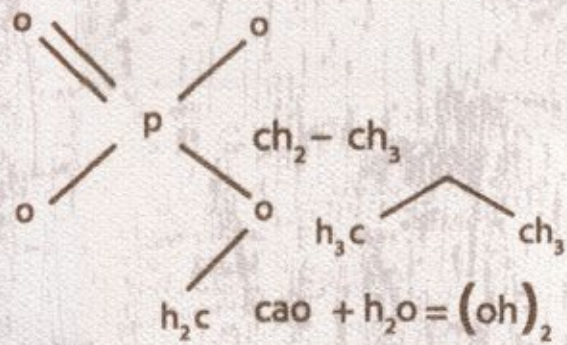
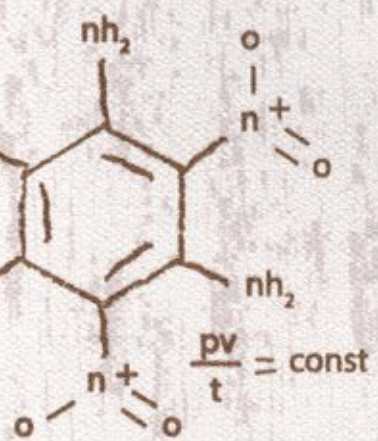
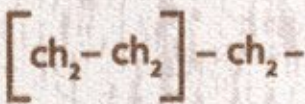

$$x \vee (y \vee z) = (x \vee y) \vee z$$

$$x \wedge (y \wedge z) = (x \wedge y) \wedge z$$

$$x \vee y = y \vee x$$

$$x \wedge y = y \wedge x$$

$$x \wedge (y \vee z) = (x \wedge y) \vee (x \wedge z)$$

$$x \vee 0 = x$$

$$x \vee 1 = 1$$

$$x \wedge 0 = 0$$

1211-01

1204-01

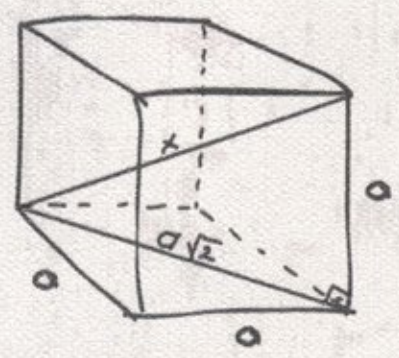
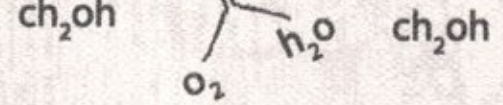

$$x^2 = a^2 + (a\sqrt{2})^2$$

$$x^2 = a^2 + 2a^2$$

$$x^2 = 3a^2$$

$$x = a\sqrt{3}$$

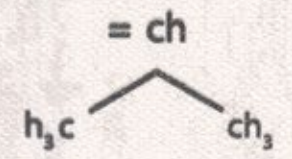
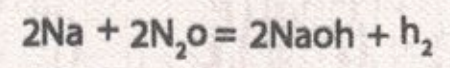
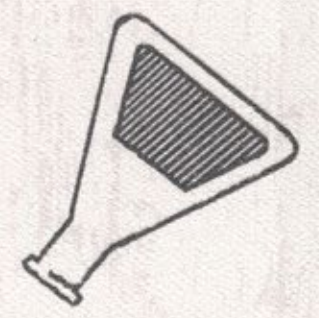
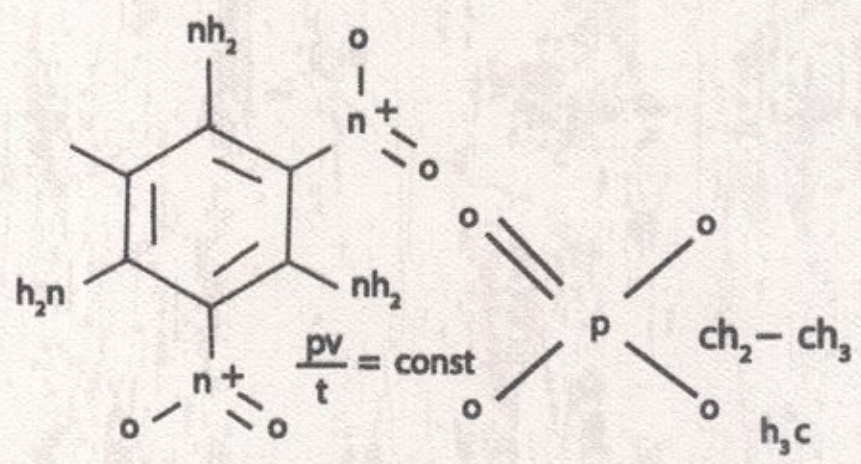
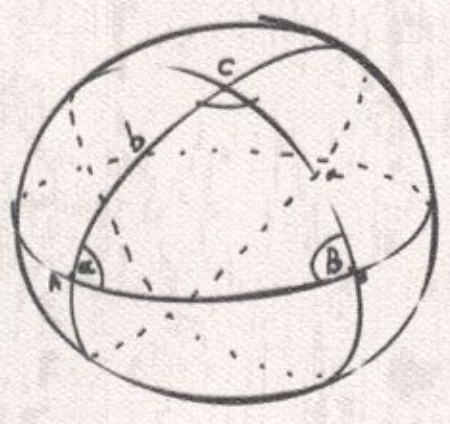
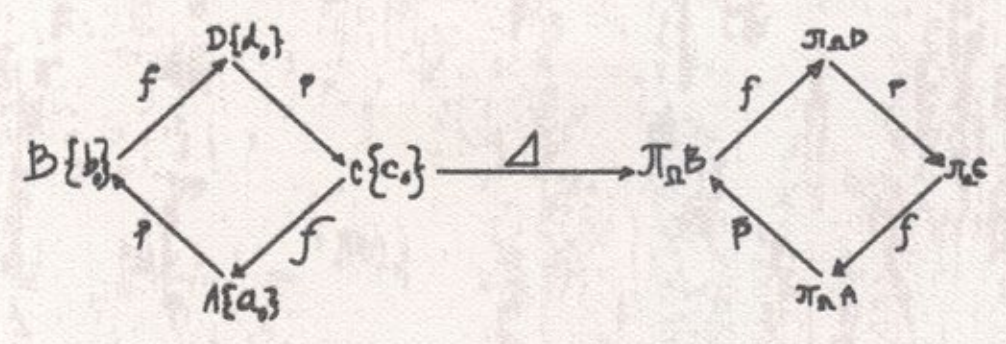

$$\frac{n \cdot (n+1)}{2}$$

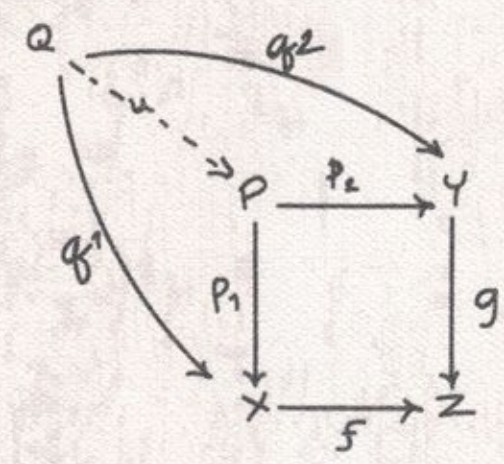

$$(x+y)^2 = x^2 + 2xy + y^2$$

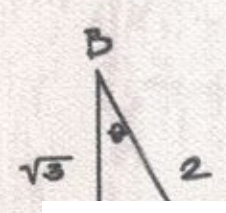
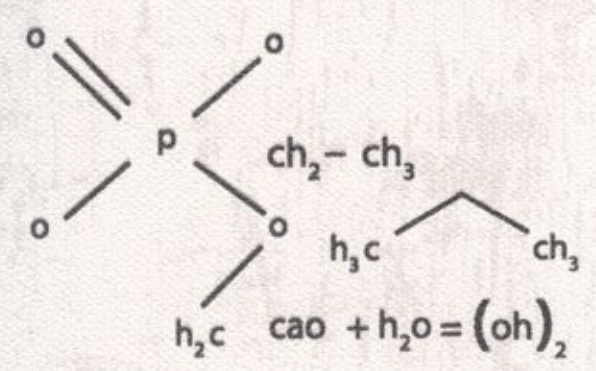
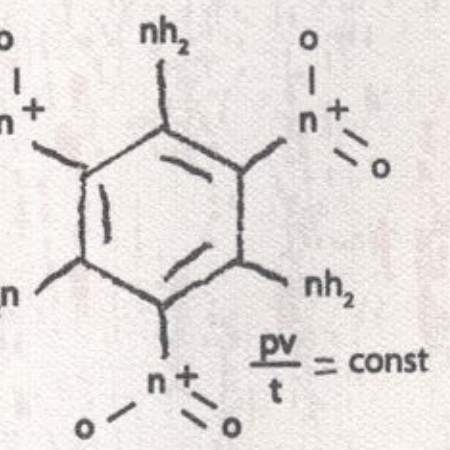
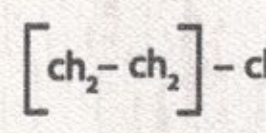
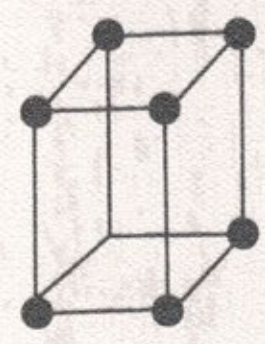

$$x \vee (y \wedge z) = (x \vee y) \wedge z$$

$$x \wedge (y \vee z) = (x \wedge y) \vee z$$

$$x \vee y = y \vee x$$

$$x \wedge y = y \wedge x$$

$$x \wedge (y \vee z) = (x \wedge y) \vee (x \wedge z)$$

1211-03

1204-03





1218-01

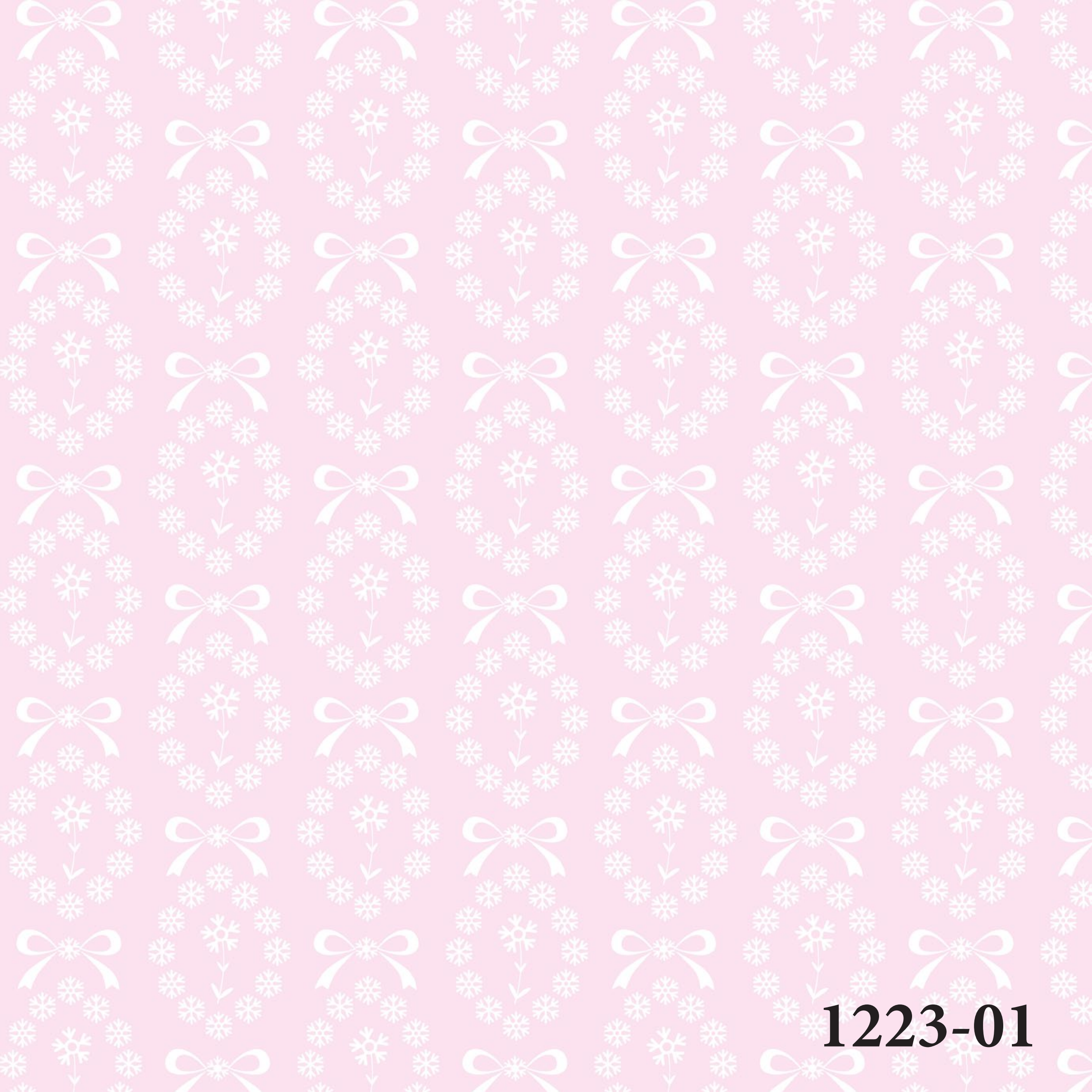

1223-01



1223-02

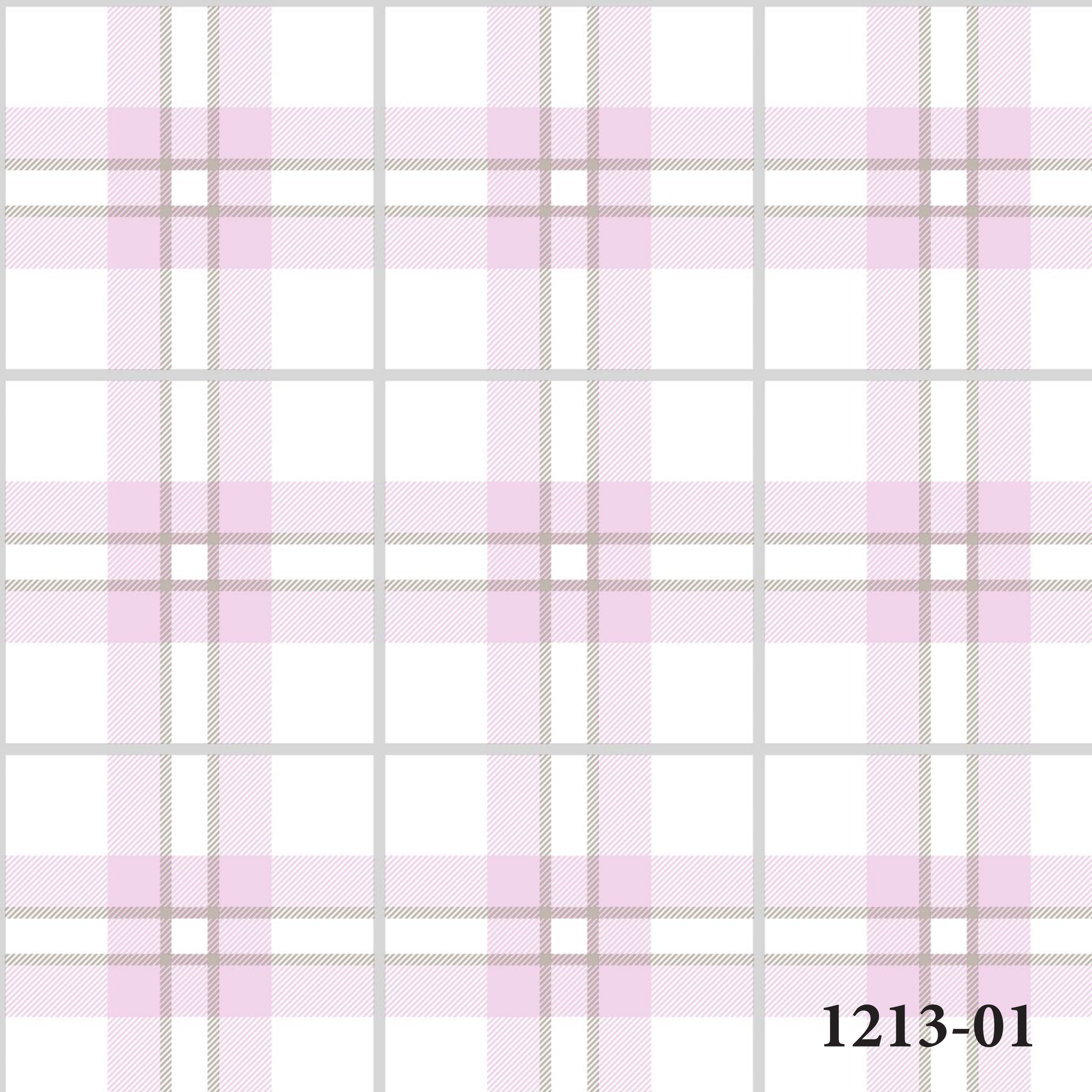

1213-01

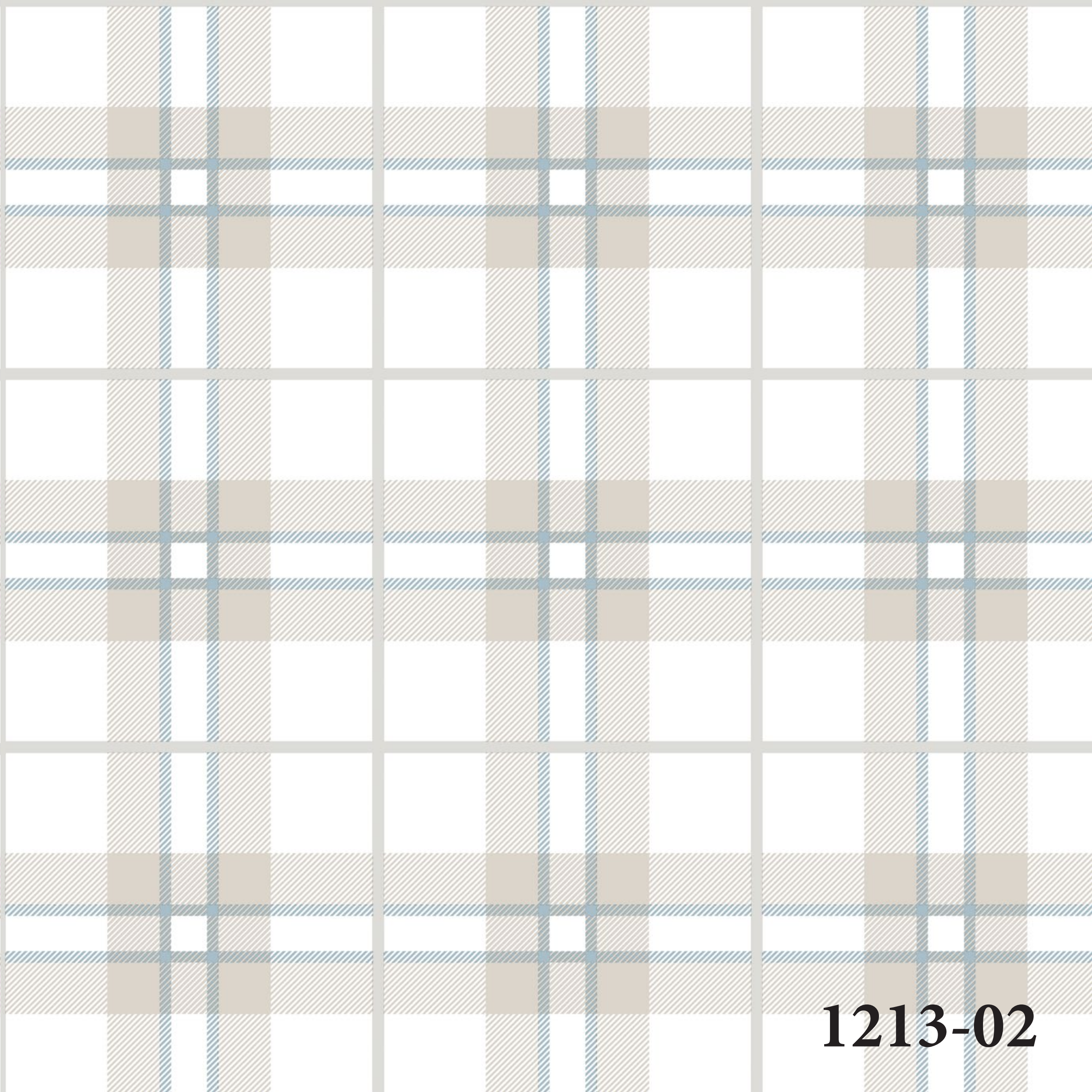

1213-02

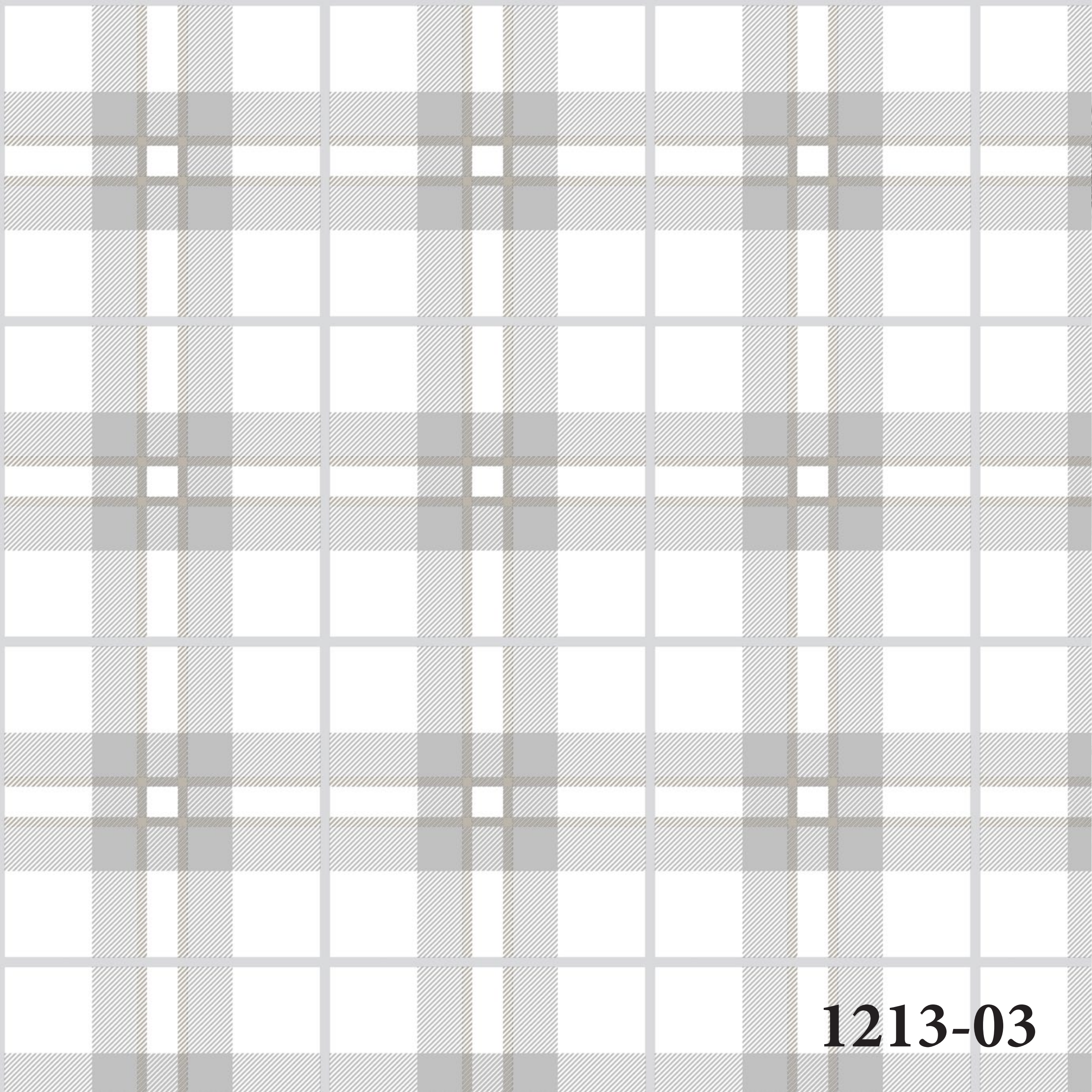

1213-03



all about LANCE
to the sea
darling so it goes
some things
are better
be?
ranchise et
minable decor
chic sent ma
From



1220-01



1220-02

1222-01

ING

LOCALS



ONLY

BAKER STR

E. 2ND

CAUTION

LOUD
MUSIC
ZONE



EXIT

WAY
OUT

BANG!

S
L
M

NO PARK

ALERT!



**VIDEO GAME
IN PROGRESS**

UNAUTHORIZED ENTRY
WILL BE ELIMINATED

EET



ST.

ROUTE

66

PEED
LIMIT

20
MILES



STOP

1221-01

1216-03

1219-05